

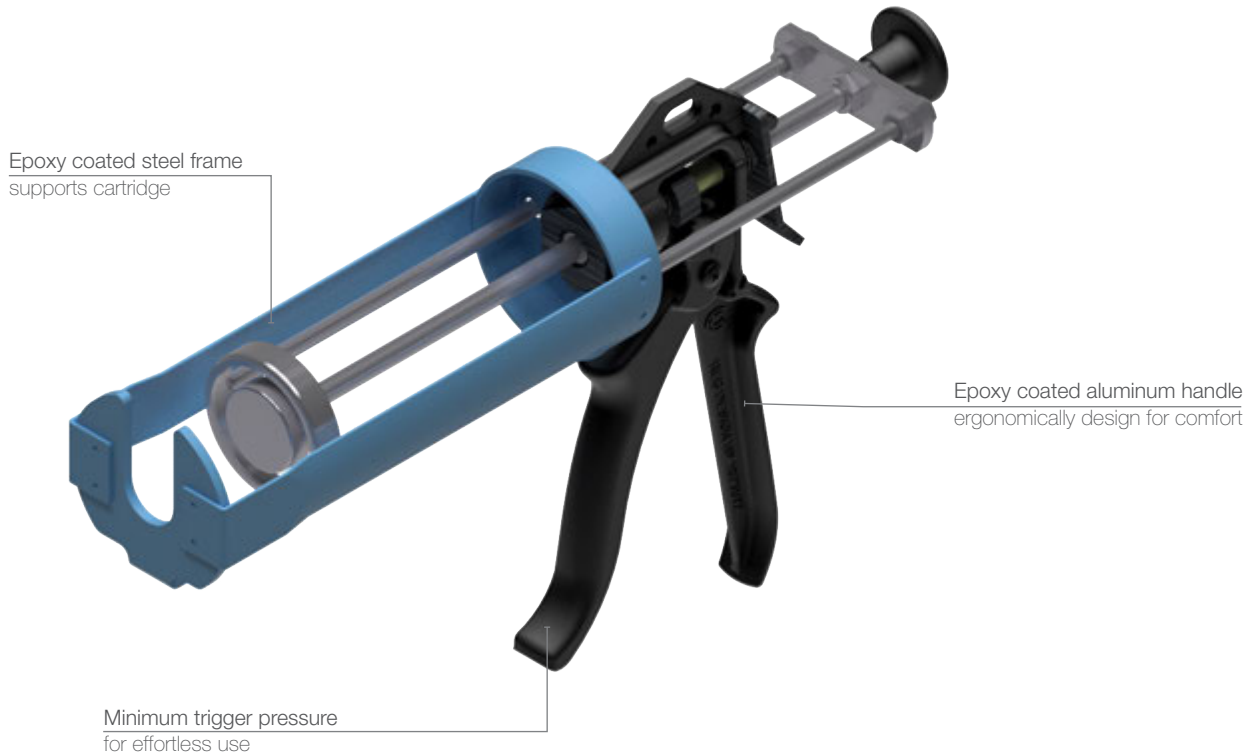

COX™ 2-Component Dispenser

CCM 380

A 2-component manual dispenser for 380mL cartridges.



Model shown: CCM 380

Product advantages

- High power 18:1 mechanism
- Reduced risk of fatigue
- Compact coaxial frame
- Robust steel frame
- Warranty up to 2 years*

Customer benefits

- Less force required
- Increased productivity
- Higher volume for repetitive applications
- Locates cartridges securely to maintain ratios
- Gives you long worry free performance

Applications



Product by range

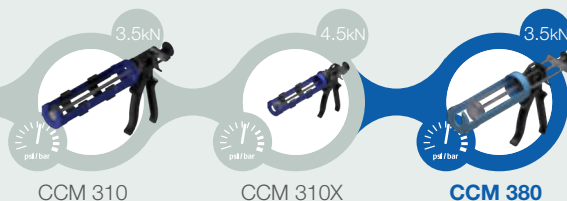

*Effective 1st July 2018

The **CCM 380** is part of a range of manual bi-mixer dispensers, designed for use with medium to high viscosity sealants and adhesives.

Specifications

- Lightweight: 1.1kg / 2.3lbs
- Cartridge Holder Length: 181mm / 7.1in
- Maximum Thrust: 3.5kN
- Handle Material: Epoxy Coated Aluminum
- Frame Material: Epoxy Coated Steel
- Tool Component Approvals: REACH
- Cartridge Capacity: 380mL (13.4oz)
- Cartridge Ratio: 1:1, 2:1, 5:1, 10:1
- Mechanical Advantage Ratio: 18:1
- Viscosity: Medium/High
- Standard Color: Black/Blue
- Customized versions: Yes

Dimensions

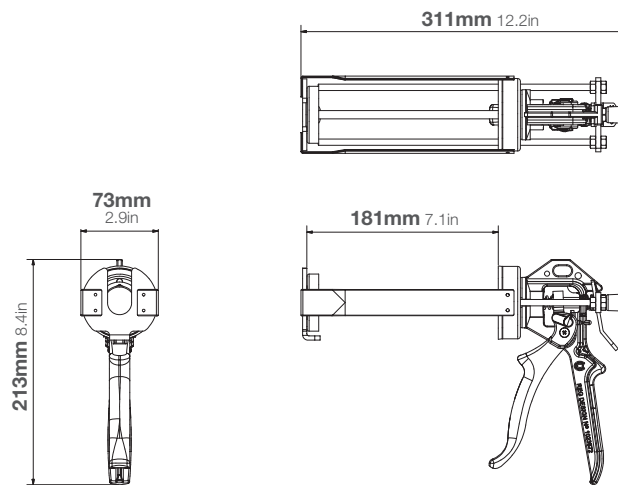

Part number:

CCM 380-1 (US)
CCM 380-2 (US)
CCM 380-5 (US)
CCM 380-10 (US)

Colour:

black/blue
black/blue
black/blue
black/blue

Article number:

AW1001 (1:1)
AW1104 (2:1)
AW1106 (5:1)
AW1222 (10:1)

Colour:

black/red
black/red
black/red
black/red

Packaging:

10 per Box
10 per Box
10 per Box
10 per Box

Matching MIXPAC™ coaxial cartridges



Q-System Cartridge
380mL 10:1 / PA

Compatible coaxial cartridges

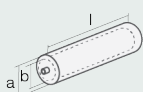

Plastic Cartridge
380mL 1:1 / PP

	mm	inch
l	183.0	7.2
a	Ø 63.0	Ø 2.4
b	Ø 41.0	Ø 1.6

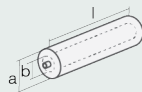

Plastic Cartridge
380mL 2:1 / PP

	mm	inch
l	183.0	7.2
a	Ø 63.0	Ø 2.4
b	Ø 33.5	Ø 1.3

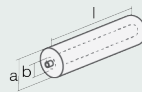

Plastic Cartridge
380mL 5:1 / PP

	mm	inch
l	183.0	7.2
a	Ø 63.0	Ø 2.4
b	Ø 25.2	Ø 1.0

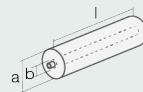

Plastic Cartridge
380mL10:1 / PP

	mm	inch
l	183.0	7.2
a	Ø 63.0	Ø 2.4
b	Ø 18.0	Ø 0.7

Conversion kits

Matching accessories